

ControlMySpa™

Spa Owner User Guide



www.balboawater.com/controlmyspa



TABLE OF CONTENTS

CONTROLMYSPA™ SYSTEM OVERVIEW 01	3
GATEWAY ULTRA HARDWARE CONNECTIONS 02	5
CMS™ CODE OVERVIEW 03	7
SETTING UP THE CONTROLMYSPA™ APP 04	9
CONTROLMYSPA™ WEBSITE – SPA OWNER OVERVIEW 05	17
INFORMATION MENU 06	20

ControlMySpa™ was built to provide the Spa Professionals with real-time access to the tub so you will think you are actually standing next to it. And, for your Customer, peace of mind, new app features, the ability to schedule events and equip smart heating so your spa is ready to go when you are.

WELCOME TO CONTROLMYSPA™

Overview

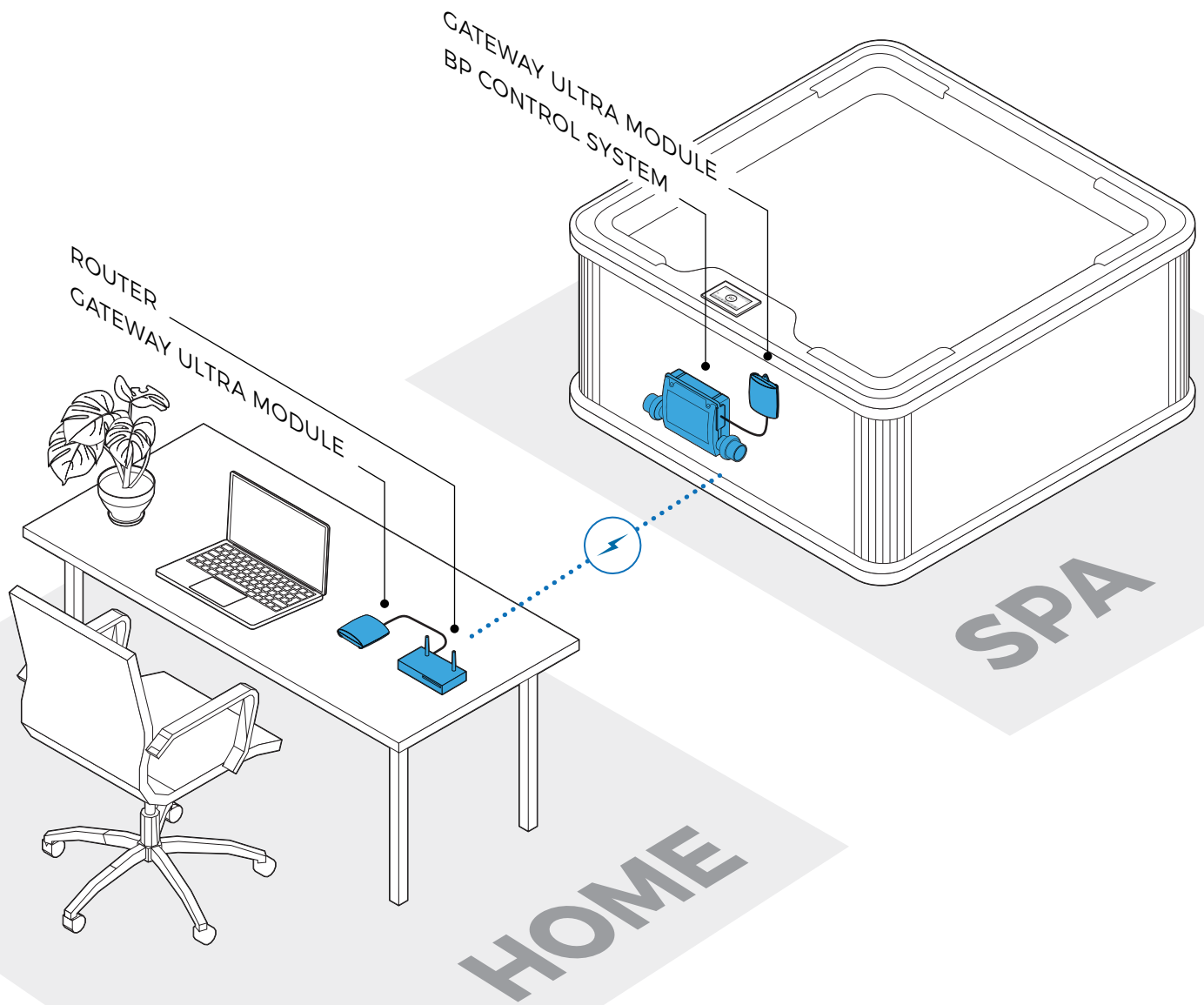

ControlMySpa™

CMS™ SYSTEM CONSISTS OF:

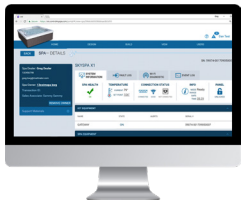

WEBSITE

ControlMySpa™ website with
Login and access to spas

CMST™ GATEWAY ULTRA Modules



Home Module



Spa Module

www.balboawater.com/GatewayUltra

SMARTPHONE | TABLET



iOS (Apple) ControlMySpa™
mobile app and/or Android
ControlMySpa™ Mobile app

The ControlMySpa™ system consists of:

- ControlMySpa™ GATEWAY ULTRA installed on a spa/Hot Tub
- iOS (Apple) ControlMySpa™ mobile app or Android ControlMySpa™ mobile app
- ControlMySpa™ website with log-in and access to spas

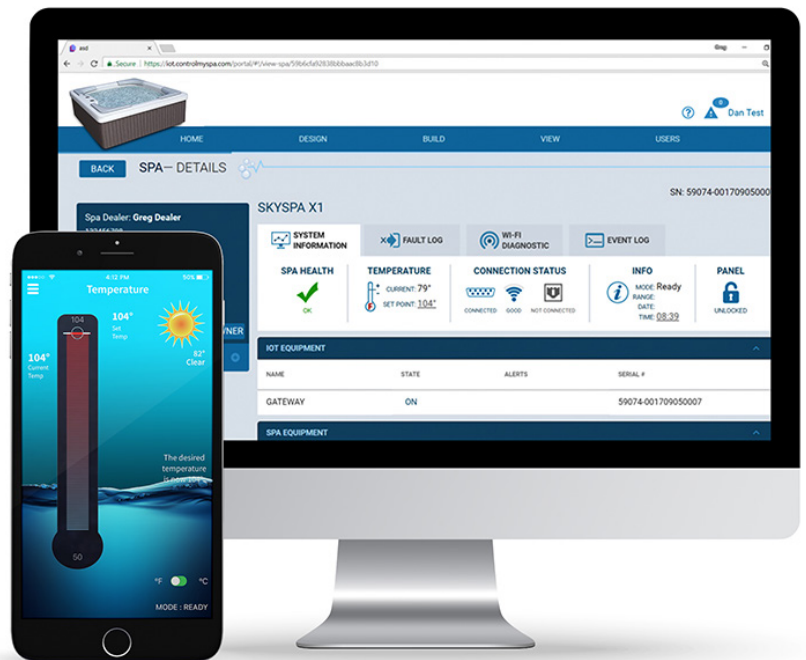

The ControlMySpa™ Logins:

- The iOS or Android ControlMySpa™ apps can only be accessed with an owner log-in
- The ControlMySpa™ website can be accessed with an owner log-in.

ControlMySpa™

GATEWAY ULTRA Hardware Connections

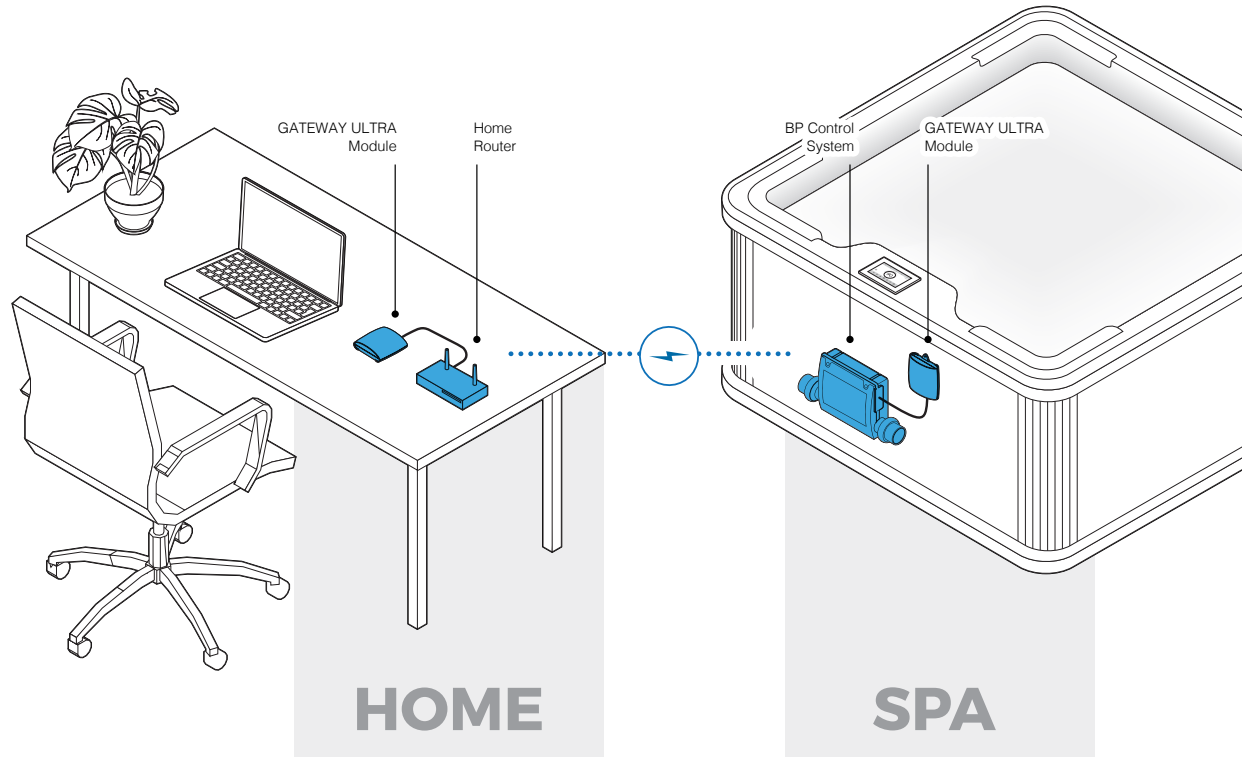

GATEWAY ULTRA Module (side view)

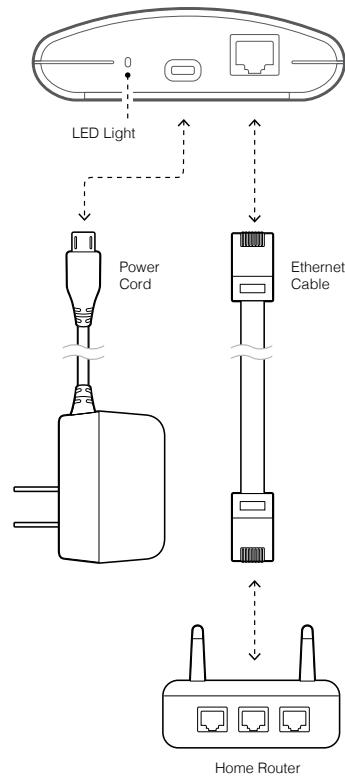

GATEWAY ULTRA Module (side view)

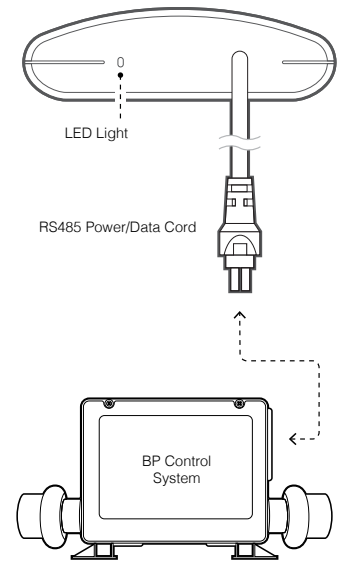

ControlMySpa™

Connect GATEWAY ULTRA hardware in your home

Step 1

Plug the supplied ethernet cable into the home router (A).

Step 2

Plug the other end of the ethernet cable into the GATEWAY ULTRA module (B).

Step 3

Plug the supplied power cord into the GATEWAY ULTRA module (C).

Step 4

Plug the other end of the supplied power cord into wall power (D).

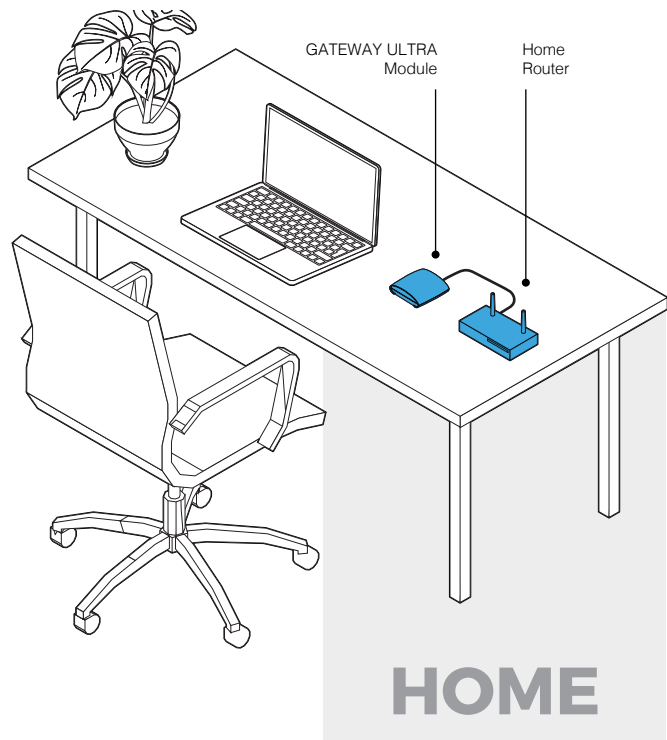



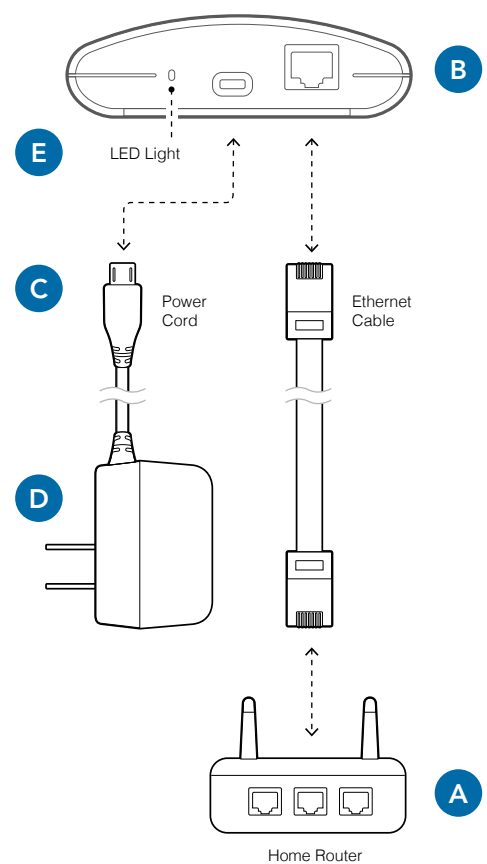

GATEWAY ULTRA Module (side view)



LED Light Chart (E)

This chart applies to the home and spa GATEWAY ULTRA modules.

-  Red - Solid: The GATEWAY ULTRA and the spa are not connected.
-  Red - Blinking: Home and spa GATEWAY ULTRA modules are connected, but no connection to the spa controller.
-  Blue - Blinking: Remote software update is underway. Do not unplug power.
-  Green - Blinking: CMS™ GATEWAY ULTRA spa and home modules RF is connected, but no connection to internet.
-  Green - Solid: Spa successfully connected to internet. No errors.

ControlMySpa™ App for the smart device

FOR IPHONE® OR IPAD® (IOS/APPLE)

Search the Apple iOS App Store for
“controlmyspa”

Or Use this link: <https://goo.gl/j31t1V>



FOR ANDROID® PHONES/TABLETS

Search Google Play App Store for
“controlmyspa”

Or Use this link: <https://goo.gl/CG4Yci>



**Control your tub
from your smart device.**

ControlMySpa™

CMS™ Code Overview

WHAT IS A CMS™ CODE?

- CMS™ Code is an 8 digit letter/number combination that all Spa owners must have to use spas equipped with the ControlMySpa™ system
 - A. The CMS™ code is obtained from your Dealer.
- Spa owners will need this CMS™ code to setup and connect their spas in the ControlMySpa™ database.
- The CMS™ code connects your spa to your OEM and Dealer for service and support

EXAMPLE CMS™ Code: ABC-12345

ABC = 3 letter code unique to each spa Manufacturer or OEM

12345 = 5 number code unique to each spa Dealer or Distributor

ControlMySpa™

Setup Spa Owner User Account

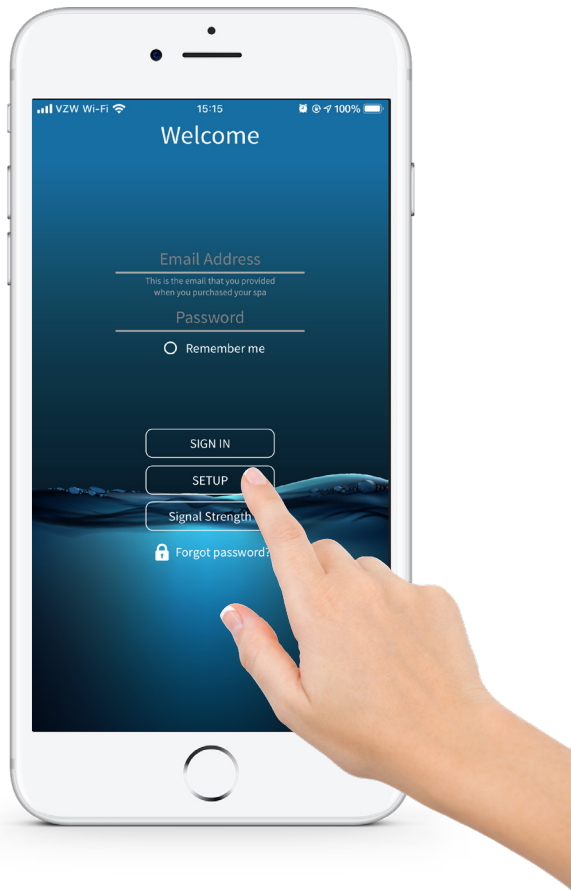

1.

Open the app on your smart device

Press "SETUP" on the app.



2.

Press "Next"

Confirm Bluetooth is ON in the iOS Settings.

ControlMySpa™

Setup Spa Owner User Account

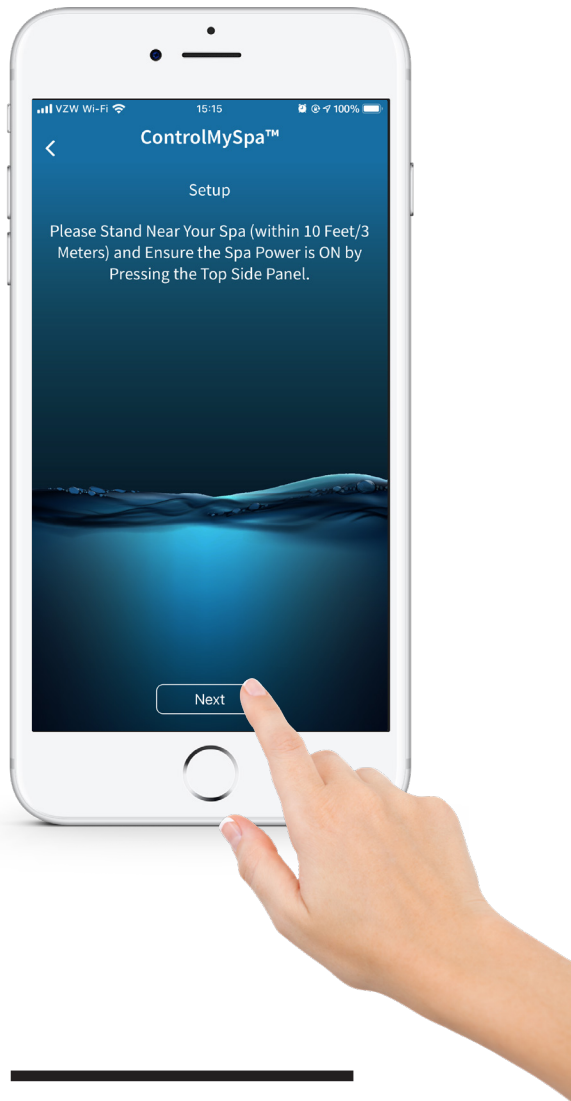

3. Press “Next”

Stand near your spa (within 10 feet/3 meters) and ensure the spa power is ON by pressing the topside panel. If the spa is powered ON, press “Next”.

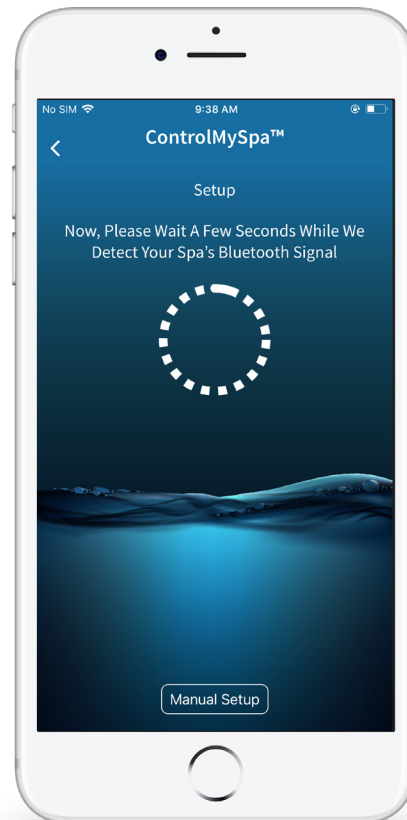

4. Detect Bluetooth

ControlMySpa™

Setup Spa Owner User Account



5. Press “Yes”

The serial number in the app should match the serial number on the back of the spa module.

6. Press “Next”

The CMS code is provided by your Dealer. Press “Next”.

ControlMySpa™

Setup Spa Owner User Account

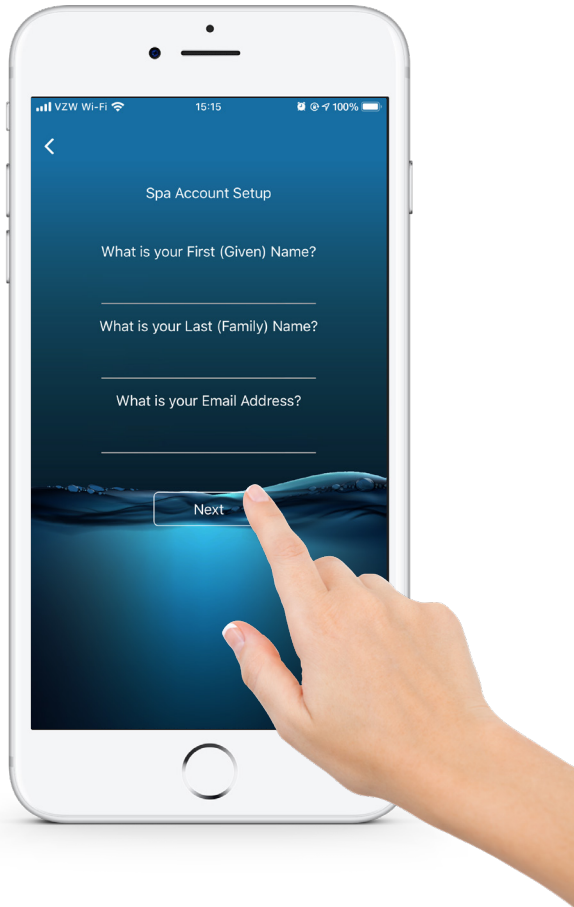

7. Press "Next"

Input information and press "Next".



8. Press "Next"

Input information and press "Next".

ControlMySpa™

Setup Spa Owner User Account

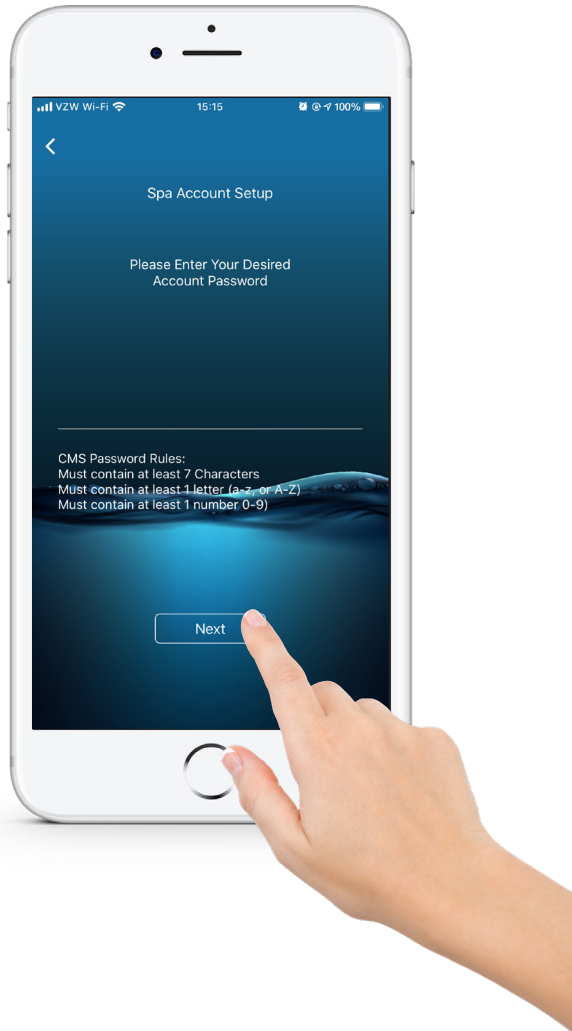

9.
Press “Next”

Input information and press “Next”.



10.
Press “Next”

Your UserID and password will appear. Press “Next”.

ControlMySpa™

Setup Spa Owner User Account



-
- 11.**
Press "Close"



-
- 12.**
Press "SIGN IN"

Input your email address, password and press "SIGN IN".

ControlMySpa™

Setup Spa Owner User Account

SUCCESS! YOUR ACCOUNT IS SETUP, AND YOU CAN CONTROL YOUR SPA WITH THE CMS APP.

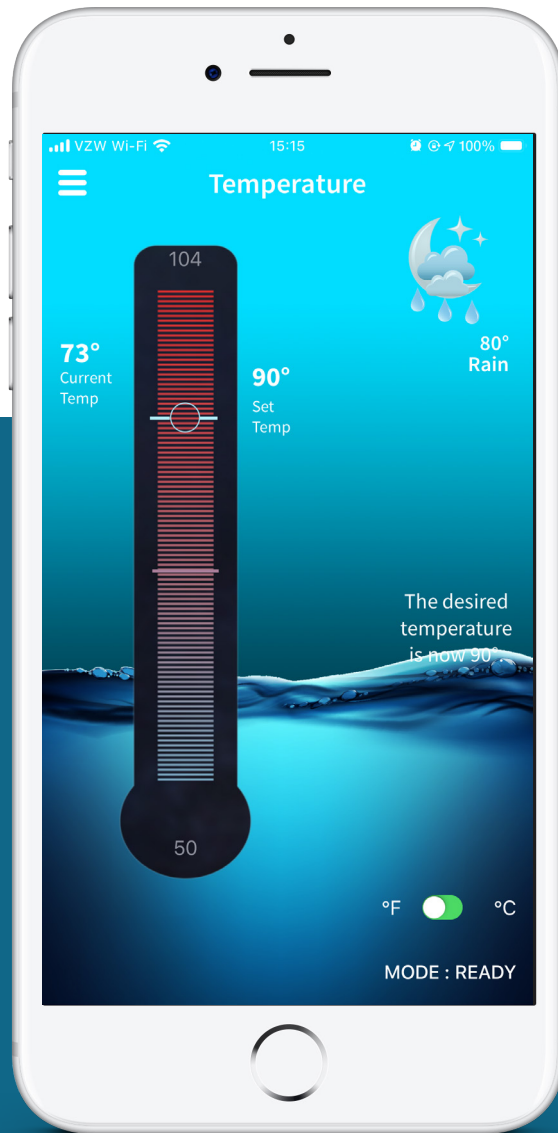

ControlMySpa™ Spa Owner Account Password

THE USER ACCOUNT EMAIL WILL RECEIVE AN AUTOMATED EMAIL:

At the e-mail address provided in the set-up, this email provides the new user their **LOG-IN** and **PASSWORD**.

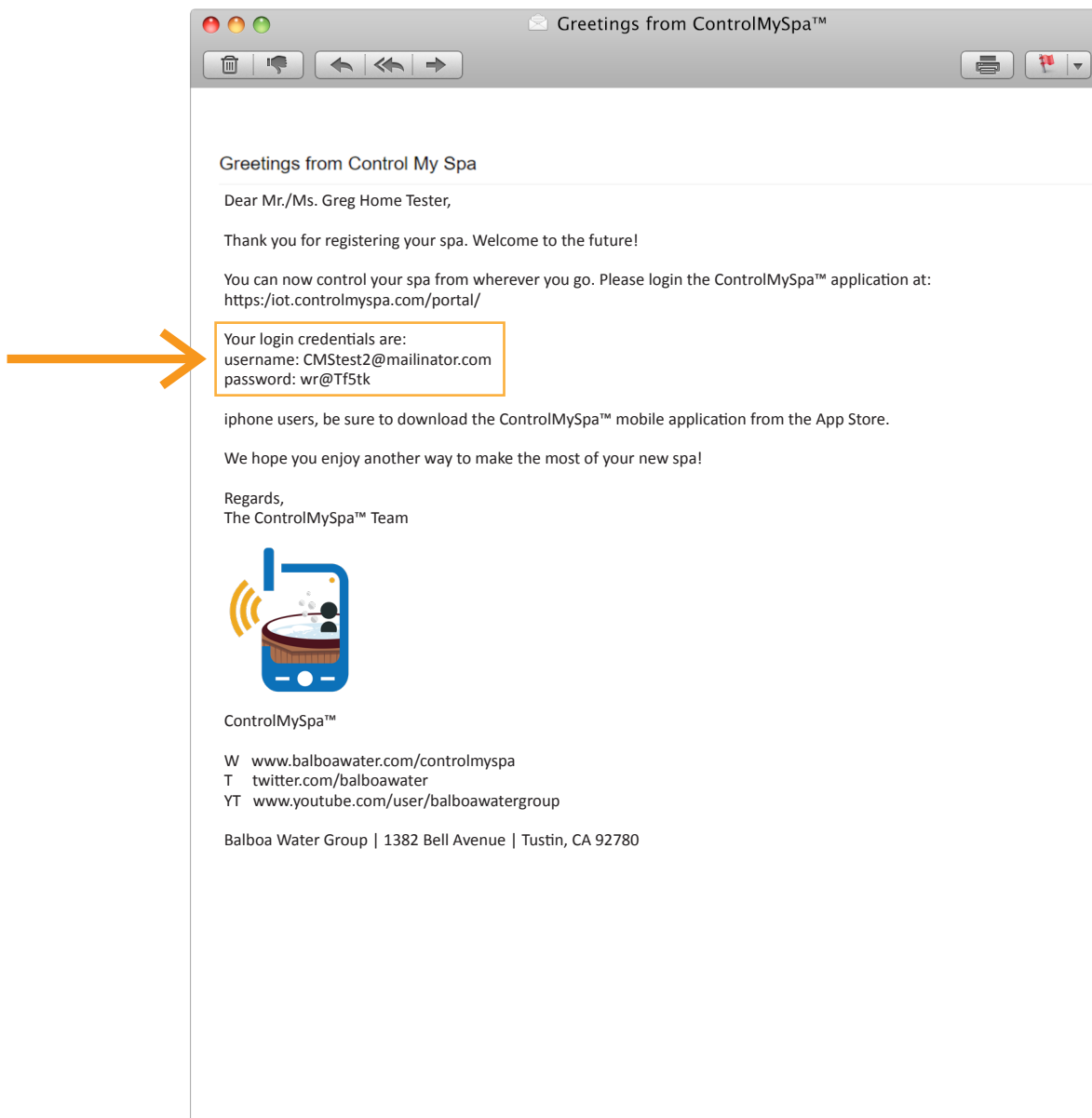

ControlMySpa™ Website Overview

SPA OWNER

ControlMySpa™

Spa Owner Overview

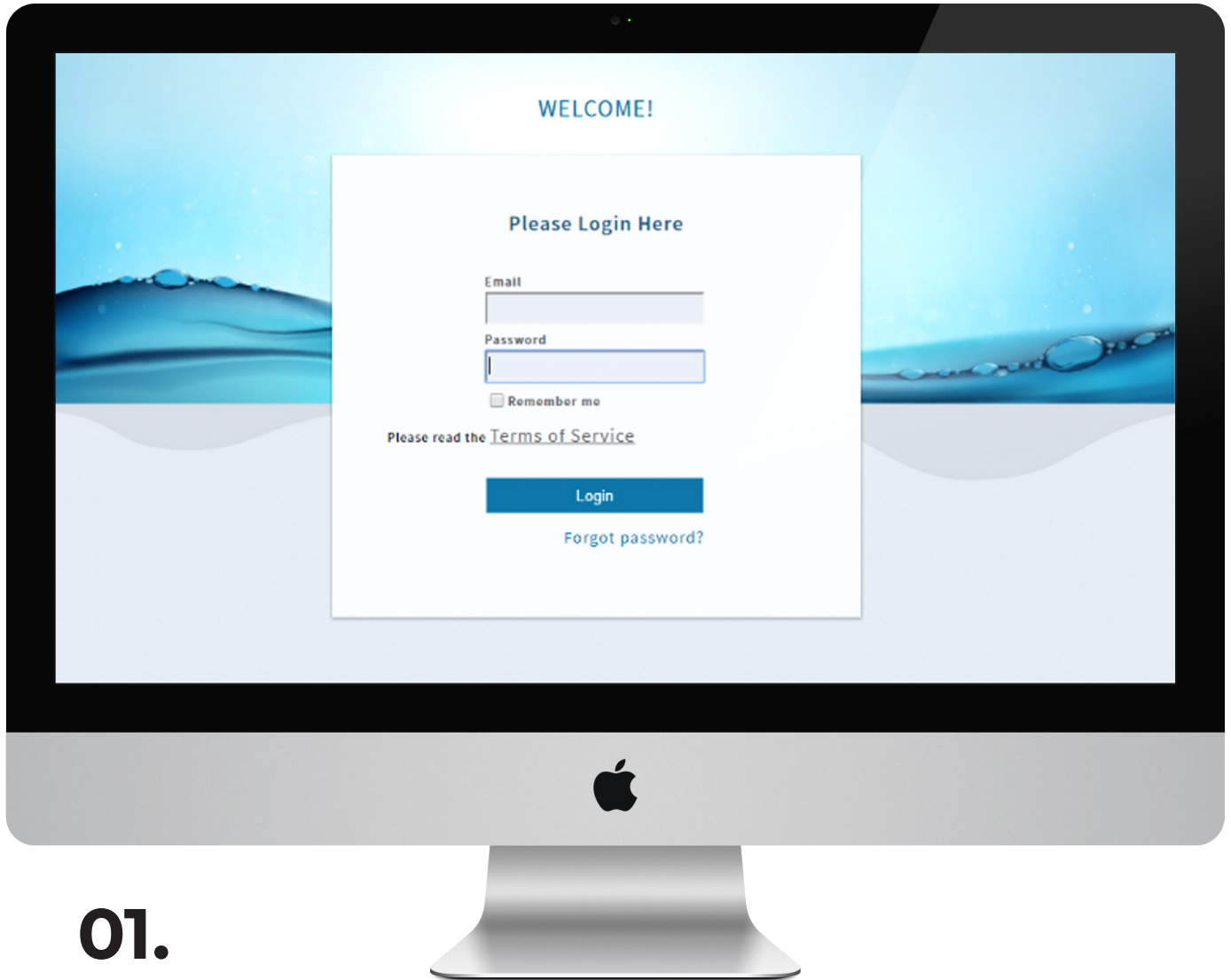

01. Web Portal Login

<https://controlmyspa.com>

Login & Password

- Go to <https://controlmyspa.com> on a computer or tablet web browser. You can also use a phone web browser, but works best on a computer or tablet
- Google Chrome browser is recommended, but works with most other browser

ControlMySpa™

Spa Owner Overview

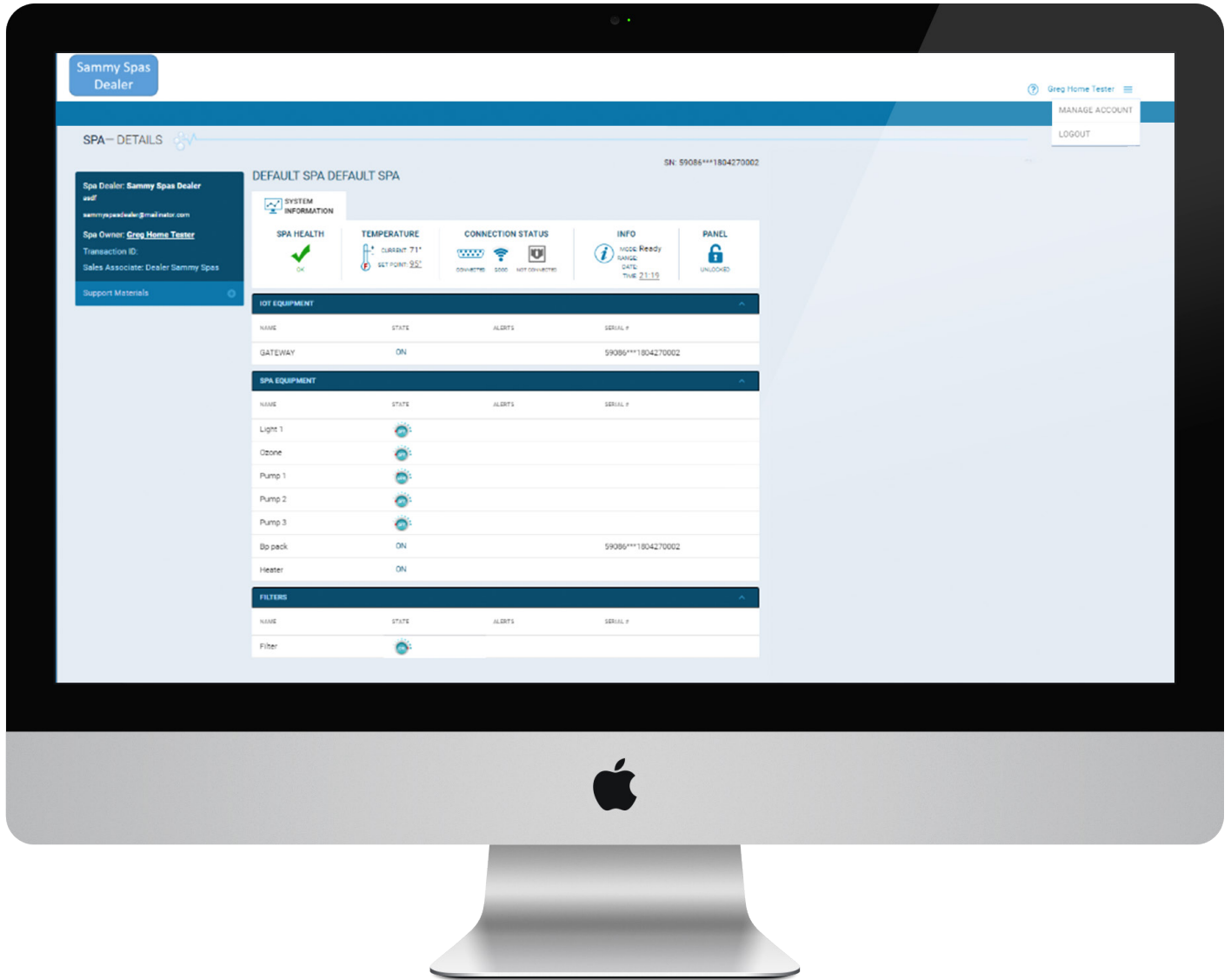

SPA VIEW PAGE

The Information Menu

CONTROLMYSPA™ SUPPORT

Trademark | Patent Notices

The iPhone®, iOS®, iPod® and iPad® are a registered trademark of Apple Inc. The iPhone®, iOS®, iPod® touch and iPad® are a trademark of Apple Inc., registered in the U.S. and other countries.

©Samsung Telecommunications America, LLC (“Samsung”). Samsung, Galaxy S, Super AMOLED, and AllShare are all trademarks of Samsung Electronics Co., Ltd. and/or its related entities. Other company names, product names and marks mentioned herein are the property of their respective owners and may be trademarks or registered trademarks. Appearance of device may vary.

Wi-Fi®, the Wi-Fi CERTIFIED logo, and the Wi-Fi logo are registered trademarks of the Wi-Fi Alliance.

Google, Google Play and other marks are trademarks of Google, Inc.

CMS, ControlMySpa™, BALBOA WATER GROUP and the stylized logo are registered trademarks or applications applied for in the US Patent & Trademark Office. All rights reserved. All other product or service names are the property of their respective owners.

Products are covered under one of more

of the following US Patents: 5332944, 5361215, 5550753, 5559720, 5,883,459, 6282370, 6590188, 7030343, 7, 417, 834 B2 & Canadian Pt 2342614 plus others. Other patents both foreign and domestic applied for and pending.

Compatibility

Apple iOS

The iOS® app version requires iOS 9.0 or later. Compatible with iPhone, iPad, and iPod touch.

Android

Requires Android 4.0 and up

INTELLECTUAL PROPERTY ADVISEMENT

All Intellectual property, as defined below, owned by or which is otherwise the property of Balboa Water Group or its respective suppliers relating to the Balboa Water Group BP Spa Control Systems, including but not limited to, accessories, parts, or software relating to the “System”, is proprietary to Balboa Water Group and protected under federal laws, state laws, and international treaty provisions. Intellectual Property includes, but is not limited to, inventions (patentable or unpatentable), patents, trade secrets, copyrights, software, computer programs, and related documen-

tation, and other works of authorship. You may not infringe or otherwise violate the rights secured by the Intellectual Property. Moreover, you agree that you will not (and will not attempt to) modify, prepare derivative works of, reverse engineer, decompile, disassemble, or otherwise attempt to create source code from the software. No title to or ownership in the Intellectual Property is transferred to you. All applicable rights of the Intellectual Property shall remain with Balboa Water Group and its suppliers.



ControlMySpa™

✉ Email

info@balboawater.com

☎ Phone

P : + 714.384.0384
Customer Service is available:

M — T 7:30AM to 7:00PM
F — 7:30AM to 5:00PM PT

📍 Corporate Office

Balboa Water Group
3030 Airway Avenue
Costa Mesa, CA 92626

MEXICO OPERATIONS
Balboa Water Group
Aguila Azteca 6011
Baja Maq. El Aquila
Mexico 22221

EUROPEAN OPERATIONS
Balboa Water Group
Hydroair International
ApS Roustvej 50 DK-6800
Varde